





Panel Surface Mount Kit





81850, 92822, 92823







Thank you for purchasing this accessory. Please read the instructions carefully before use to ensure safe and satisfactory operation of this product. Please retain these instructions for future reference.

Check you have all necessary prts:

- 81850:**
- 4 x plastic plugs 
 - 4 x screws 
 - 2 x mounting frame pieces with fixing holes 
 - 2 x mounting frame pieces without fixing holes 
 - 4 x corner connectors 

- 92822:**
- 4 x plastic plugs 
 - 4 x screws 
 - 2 x mounting frame pieces with fixing holes 
 - 2 x mounting frame pieces without fixing holes 
 - 4 x corner connectors 

- 92823:**
- 4 x plastic plugs 
 - 4 x screws 
 - 2 x mounting frame pieces with fixing holes 
 - 2 x mounting frame pieces without fixing holes 
 - 4 x corner connectors 

Installation

81850 surface mount kit is suitable for 595*595 panels.

92822 surface mount kit is suitable for 1195*595 panels.

92823 surface mount kit is suitable for 1195*295 panels.

Please refer to the installation instructions supplied with the fitting for wiring and connection details.

Note that the switch is turned off before installation.

The ceiling surface must be flat and smooth to ensure a good fit.

- Using four corner connectors connect to two mounting frames (without fixing holes) and push to secure. After completion such as mounting frame **A** (See Fig. 1).
- Slide two mounting frames **B** (with fixing holes) separately into a mounting frame **A** (with corner connectors) and push to secure (See Fig.1). Ensure the 2 opposite sides of the 3 sided frame have fixing holes. (See Fig.2)
- Using the part-assembled frame as a template, mark and drill the fixing holes on the ceiling. Take care not to damage any concealed wiring or pipes. Then fix the part-assembled frame to ceiling using the supplied plastic plugs and screws. (See Fig.3)
- Referring to Fig.4, connect the driver as per the instruction manual supplied with the panels and carefully slide the panel into the 3 sided frame.
- Slide the fourth frame **A** (with two corner connectors) into the part-assembled and push to secure (See Fig.5).
- Replace fuse or circuit breaker and switch on. Your light is now ready for use.

Fig.1

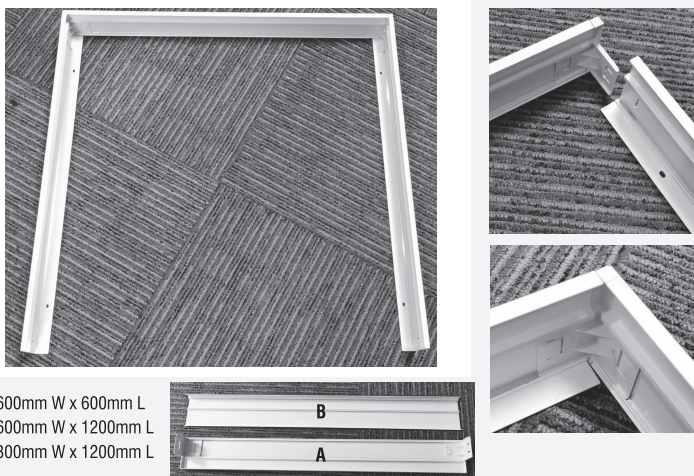

Fig.2

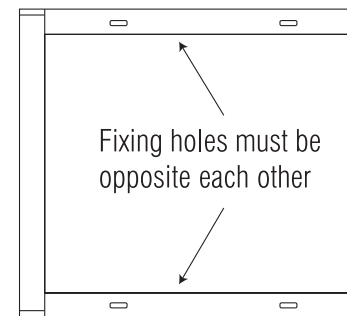

Fig.4

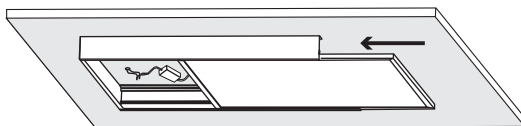

Fig.5

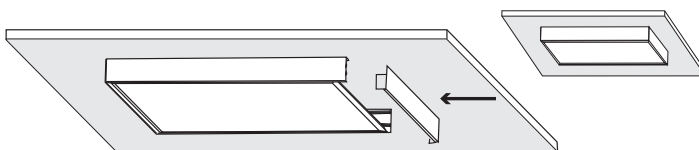
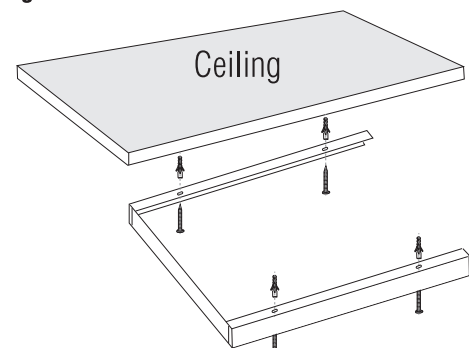

Fig.3



* Product images may vary.

Recycling advice



Conformity with all relevant EC Directive requirements.



Conformity with all relevant UKCA Directive requirements.



Waste electrical products should not be disposed of with household waste. Please recycle where facilities exist. Check with your Local Authority or local store for recycling advice.

Safety information

For your safety, always switch off the power supply before cleaning.

V9 27/03/2024

UK Manufacturer: BH17 7BY

EU Manufacturer: Brilliant AG,
 Brilliantstrasse 1, D-27442 Gnarrenburg

saxby
lighting