

Technical data

Supply Voltage: 220-240 V~, 50 Hz

Bulb Type: 2W LED module (SMD) CCT, 3000/4000/6000K

This product contains a light source of energy efficiency class **F**.

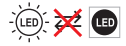

Non-replaceable light source

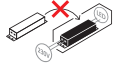

Non-replaceable control gear



Conformity with all relevant UKCA Directive requirements.



Conformity with all relevant EC Directive requirements.



The power supply is Double Insulated and does not require connection to an Earth circuit.



Waste electrical products should not be disposed of with household waste. Please recycle where facilities exist. Check with your Local Authority or local store for recycling advice.



This product is not suitable for dimming.



This product is rated at IP65.



This product is rated at IK08.

Care and Safety

We recommend cleaning with a soft dry cloth. Do not use solvents or abrasive cleaners as these could damage the finish. For your safety, always switch off the power supply before cleaning.

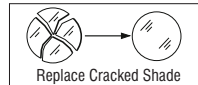

This light source is protected by a shade. This part must be replaced immediately should the shade become cracked or damaged. This fitting must not be used without the shade in place.

Instruction manual

Severus Landscape Indirect

61214, 40104

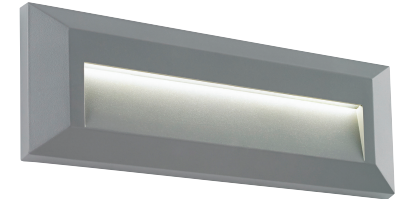

Thank you for purchasing this light fitting. Please read the instructions carefully before use to ensure safe and satisfactory operation of this product. Please retain these instructions for future reference.

Warning

 This power supply is Double Insulated and does not require connection to an Earth circuit.

Please read these instructions carefully before commencing any work.

This unit must be fitted by a competent and qualified electrician.

Check the pack and make sure you have all the parts listed.

Install in accordance with the IEE Wiring regulations and current Building Regulations.

To prevent electrocution switch off at mains supply before installing or maintaining this fitting. Ensure other persons cannot restore the electrical supply without your knowledge. If you are in any doubt, please consult a qualified electrician.

This light fitting should be connected to a fused circuit.

If replacing an existing fitting, make a careful note of the connections.

This product is suitable for location in or near a marine environment.

This system contains non-replaceable parts and cannot be serviced. If damage occurs the part should be scrapped.

Waste electrical products should not be disposed of with household waste. Please recycle where facilities exist. Check with your local authority or retailer for recycling advice.

Layout

Plan the desired layout of these fittings carefully, ensuring the cables will reach the distance between the junction box and the light fitting.

Avoid locating any cables in positions that would cause a hazard. Position cables and outdoor rated junction boxes (not supplied) away from areas where they may be at risk from being cut, trapped or damaged.

We recommend that you use H05RN-F specification cable (not supplied) which is an outdoor grade, rubber sheathed cable.

The mains supply cable must have a minimum cross sectional area of 1.0mm²

Cables must be protected using suitable conduit or plastic trunking.

Installation

Existing fittings must be completely removed before installation of a new product. Before removing the existing fitting, carefully note the position of each set of wires.

Note that the switch is turned off before installation.

Ensure that the screws and cable entry points are sealed to maintain the IP rating of the product.

Determine the position of your light fitting taking into account the entry position of the cable and make sure there is sufficient cable coming out of the wall to connect to the terminal block. Ensure that the mounting surface is solid, preferably a brick or block wall and ensure that there are no other cables or pipes beneath the surface.

This product is colour changing and can be either warm white (3000K) or cool white (4000K) or daylight white (6000K).

Choose your preferred colour before installing by using the CCT switch inside the product.

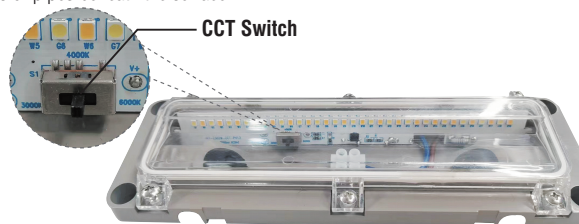

- **Diagram A.** Gently prise off the cover plate to reveal the 6 retaining screws on the sides of the unit.
- **Diagram B.** Remove these 6 x screws and retain for re-use.
- **Diagram C.** Bring the mains cable through the rubber grommet in the wall plate and then use the wall plate as a template and mark the fixings holes. Make sure the wall plate is correctly aligned so that the top of it is horizontal. Use appropriate fixings to secure the back plate to the wall.
- Wire as detailed below. When complete, wrap the terminal block in 2 layers of good quality insulation tape.
- Place the LED housing unit back onto the wall plate making sure that no cables are trapped or exposed and secure with the 6 screws removed previously. Push the cover plate – removed previously– onto the LED housing unit.
- Refit the cover plate, click in position. Replace fuse or circuit breaker and switch on. Your light is now ready for use.

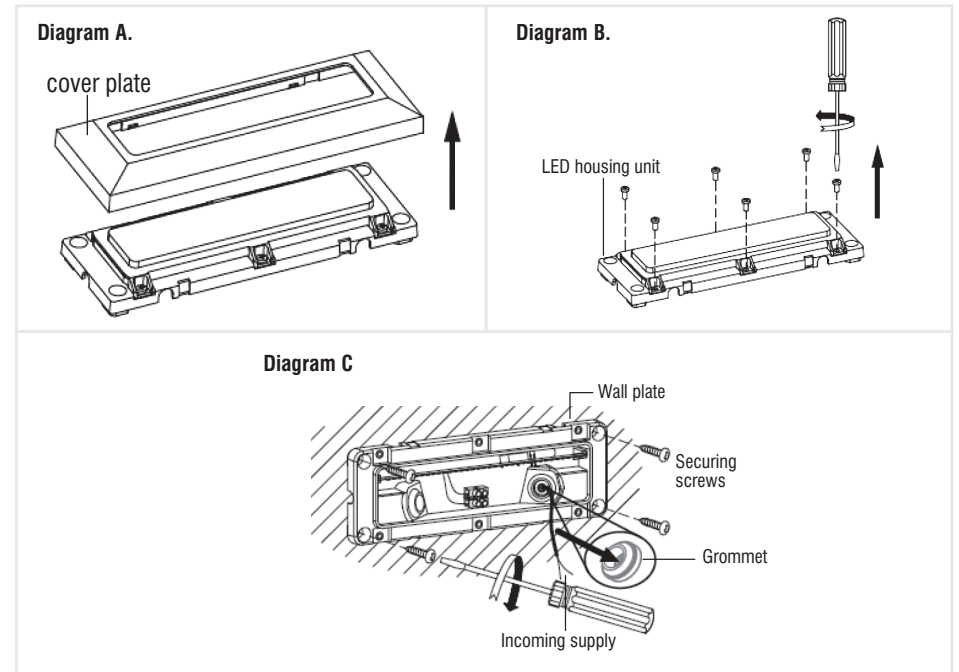

Wiring

Having correctly identified the wiring from your light fitting, connect to the approved outdoor rated external terminal block in the following way:

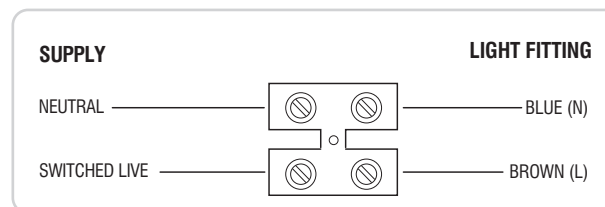

Check that...

- You have correctly identified the wires.
- The connections are tight.
- No loose strands have been left out of the connection block.
- Reseal the approved outdoor rated external terminal block.